



FEL-PRO INSTALLATION TIPS

GENERAL INSTRUCTIONS

CLEAN MATING SURFACES Use a degreaser.

CLEAN THREADS of all bolts/studs; for nuts/threads holes use a bottoming tap.

BOLT PREPARATION: Those **entering** coolant passages require pliable non-hardening sealer on threads and underside of bolt heads. Those **not entering** coolant passages require oil on threads and underside of bolt heads. **Exhaust Assembly:** Apply high temperature anti-seize lubricant to threading.

CHECK CASTINGS for flatness. Straighten, resurface or replace if needed. **CYLINDER HEAD AND BLOCK:** Refer to OEM manual to determine flatness tolerances and resurfacing limitations.

FINAL ASSEMBLY: Torque all fasteners to OEM specifications unless noted. **CYLINDER HEAD** torquing is critical; we recommend that you confirm with OEM.

HEAD GASKET

LIGHTWEIGHT CYLINDER HEADS have created potential head gasket sealing problems around the spark plug cooling water ports.

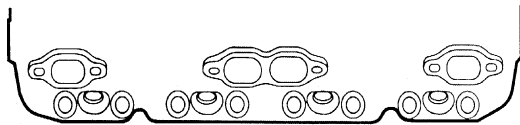

Heavy Head Contour

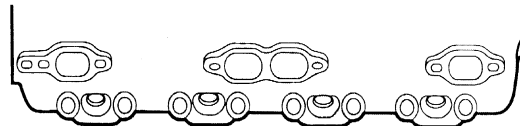

Lightweight Head Contour

To determine cylinder head type, refer to the contour differences between the heavy and lightweight cylinder heads (See drawings).

Lightweight Cylinder Head Casting Outline

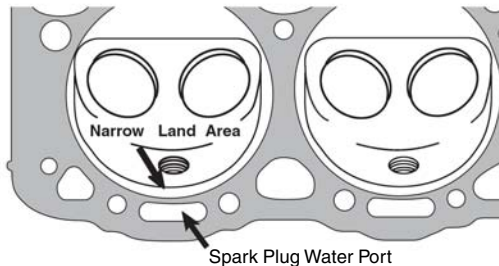

If a significant amount of core shift exists and/or head surface has been excessively resurfaced, the narrow land area between the spark plug water port and the combustion chamber will move inward toward the combustion chamber. This will reduce the amount of sealing area on the head gasket's combustion seal and cause the gasket not to seal. To insure proper fit and alignment of the gasket, check the location of the gasket's combustion seal in relation to the spark plug water port. If the gasket does not fit properly, replacement of the cylinder head may be necessary.

ATTACH AND ALIGN GASKET(S) FOLLOWING ANY DIRECTIONAL MARKINGS SHOWN ON THE GASKET. If no markings exist, simply install the gasket by matching the gasket to engine deck surface.

FIBER FACED GASKET(S) are to be installed dry. **METAL FACED GASKET(S)** require a thin event coat of sealer to be applied to the metal side(s) of the gasket.

VALVE STEM SEALS

POSITIVE GUIDE SEAL:

Use plastic installation sleeve(s), to prevent damage to lip of seal. Trim plastic sleeve so it extends 1/16" below keeper groove. Place sleeve on stem. Carefully start valve stem seal over sleeve. Remove and reuse plastic sleeve. **FOR RUBBER JACKET SEALS:** Push seal over valve guide until it bottoms. **FOR SOLID/METAL JACKET SEALS:** Use of OEM service tool is recommended. If too is unavailable, use deep socket or rigid tube of appropriate diameter. Center tool over shoulder of seal and tap seal down over guide until it bottoms

UMBRELLA TYPE SEAL:

Start valve stem seal over valve stem; push seal down on seal body until it touches top of valve stem guide. Seal will find its proper position on stem once engine starts.

VALVE COVER GASKET

Be sure to retain the load spreader washers when you remove the valve cover.

ATTACH AND ALIGN GASKET(S): Apply quick-drying adhesive, sparingly in several places on the mating surface of cover. If gasket has installation tabs, adhesive is not required, Mount gasket on cover. **Allow time for adhesive to set.** Test for slippage with light pressure if gasket moves, allow more time.

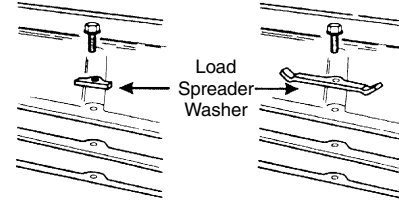

PRIOR TO REINSTALLING VALVE COVER, place a load spreader washer under each bolt head.

INTAKE MANIFOLD GASKET



This set contains 2 manifold gaskets with the center port open, and 2 stainless steel restrictor assemblies attached to one of these gaskets.

Use manifold gasket(s) with open center port(s) as supplied in this set or with restrictor assemblies in place as noted.

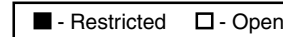

	Center Ports:	Right	Left
Passenger Car			
265, 283, 302, 307, 327 Eng.			
1973		■	□
1957-72		□	□
350 Eng.			
1978-86		□	□
1977		□	■
1976	Exc. California	□	□
	California	□	■
1975		□	■
1974	2 Barrel	■	□
	4 Barrel	■	■
1973		■	□
1967-72		□	□
Truck			
265, 283, 307, 327 Eng.			
1973		■	□
1955-72		□	□
350 Eng.			
1980-86		□	□
1979	Exc. School Bus	□	□
	School Bus	□	■
1978	1/2 Ton		
	Series 50-65	□	■
	3/4, 1 Ton		
	Series 10-30	■	■
1976-77	Exc. 4 Barrel	□	■
	4 Barrel	■	■
1975	Exc. Series 50-65	□	■
	Series 50-65	□	□
1974	Exc. Series 50-65		
	2 Barrel	■	□
	4 Barrel	■	■
	Series 50-65	□	□
1973	Exc. Series 50-65	■	□
	Series 50-65	□	□
1969-72		□	□

RESTRICTED PORT GASKET:

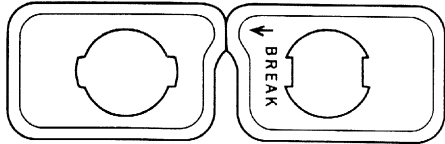

DIVIDE RESTRICTOR ASSEMBLY INTO 2 PIECES as marked. Place 1 restrictor half - with prongs up - on the work-bench.

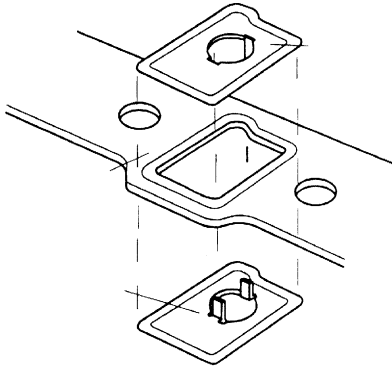

POSITION THE CENTER PORT OF THE MANIFOLD GASKET over the restrictor half. For proper fit, the offset in the gasket center port contour must match the contour of the insert.

PLACE THE OTHER RESTRICTOR HALF WITHOUT PRONGS over the gasket's center port aligning the offset contour of the restrictor with that of the gasket.

BEND THE PRONGS OF THE LOWER RESTRICTOR HALF OUTWARD over the outer edge of the upper restrictor half using a blunt tool. Make certain the prongs are pressed down tightly so that the restrictor assembly is held securely in the gasket body.

IMPORTANT: When properly installed, the outer flange of the upper and lower restrictor halves will overlap the gasket body around the center port. Failure to do so may cause restrictor to slide out of position.

ATTACH AND ALIGN END SEALS. Apply quick-drying adhesive, sparingly to cylinder block. Mount end seals. **Allow time for adhesive to set.** Test for slippage with light pressure. If seals move, allow more time.

ATTACH AND ALIGN GASKET(S) TO CYLINDER HEAD(S). Apply a quick-drying adhesive sparingly in several places on the cylinder heads, Mount gasket(s) on cylinder head(s). **Allow time for adhesive to set.** Test slippage with light pressure. If gasket moves, allow more time.

PRIOR TO REINSTALLING INTAKE MANIFOLD apply a small dab of silicone sealer, such as RTV Black to the 4 corner intersections between the end seals and gaskets.

EXHAUST MANIFOLD GASKET

ATTACH AND ALIGN GASKET(S). If gasket has only one steel faced side, install steel side towards manifold.

WATER OUTLET, WATER PUMP, FUEL PUMP AND TIMING COVER GASKETS

If a supplementary sealer is desired, apply a thin coat of gasket sealer to both sides of gasket(s).

ROTATING SHAFT SEALS

RUBBER SEAL(S): Install seal with its **raised sealing lip toward the engine.** Two-piece rubber seals may be installed using a "shoehorn" installation aid places underneath seals to protect them from sharp edges.

ROPE SEALS: Install seals into grooves of cap and block by firmly pressing packing into grooves with a "packing tool." Ensure that ends of seals protrude above face of cap and block.

IMPORTANT: Final interference of rope packing seals against crankshaft is critical. To achieve proper interference, it is best to install packing using correct **Packing Tool** for you engine. With "packing tool" in position, cut protruded ends of seals flush with cap and block.

LUBRICATE SEALING LIPS AND CRANKSHAFT with motor oil or grease. If engine will not be started within several days, grease is recommended.

IMPORTANT: Never install any seal without break-in lubricant protection.

REAR MAIN BEARING CAP: Prior to installation, apply anaerobic sealant to mating surfaces of cap or block. **AVOID** sealant of ends of seals.

OIL PAN GASKET

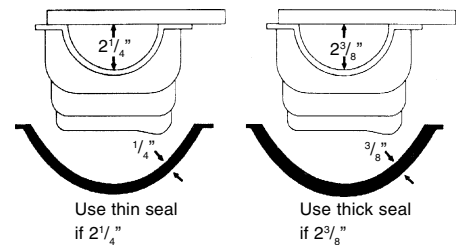

This set contains 2 oil pan front seals for Chevrolet-built small V8 engines. Identify and install the seal as follows: Lay a straightedge across the flanges at the front of the oil pan. Measure the distance from the lowest point of the front seal to the bottom of the straightedge. If distance = 2 1/4" deep install the 1/4" (thin) seal. If distance = 2 3/8" deep install the 3/8" (thick) seal.

ATTACH AND ALIGN END SEAL. Apply quick-drying adhesive sparingly in several places in the groove of the rear main bearing cap. Mount seal in the groove. **Allow time for adhesive to set.** Test for slippage with light pressure. If seal moves, allow more time.

ATTACH AND ALIGN GASKETS. Apply quick-drying adhesive sparingly in several places on the engine casting or oil pan (depending upon engine model). Mount gasket (or gaskets and seals, if multipiece) on surface where adhesive was applied. **Allow time for adhesive to set.** Test for slippage with light pressure. If gasket moves, allow more time.

PRIOR TO INSTALLING OIL PAN apply a small dab of silicone sealer, such as RTV Black, where all gaskets and seal(s) meet.